

POWERPAK

COMMERCIAL STEAMBATH GENERATOR

THERMASOL

MADE IN U.S.A.

ThermaSol PowerPak Series Installation & Operating Instructions Commercial Steam Bath Generators (Three Phase)

CUSTOMER WARNINGS

- DO NOT USE THIS PRODUCT UNLESS YOU HAVE CONSULTED YOUR DOCTOR AND RECEIVED WRITTEN PERMISSION TO DO SO. USE OF THIS PRODUCT MAY BE HAZARDOUS TO YOUR HEALTH.
- STEAM IS HOT! DO NOT TOUCH OR GO NEAR THE STEAM HEAD FROM THE TIME THE UNIT IS "ON", UP TO ONE HOUR FROM THE TIME THE UNIT IS OFF. SEVERE BURN WILL OCCUR IF YOU COME IN CONTACT WITH THE STEAM HEAD OR STEAM EMITTING FROM THE STEAM HEAD.
- NEVER ATTEMPT TO FILL AROMA THERAPY RESERVOIR ON THE STEAM HEAD WHEN UNIT IS IN THE "ON" POSITION. SEVERE BURNS WILL OCCUR.
- DO NOT USE THERMASOL AROMA THERAPY OILS OR SKIN CARE PRODUCTS OR ANY PRODUCT IN CONJUNCTION WITH YOUR THERMASOL UNIT WITHOUT CONSULTING WITH YOUR ALLERGIST OR DOCTOR BEFORE USE. THESE PRODUCTS MAY BE HAZARDOUS TO YOUR HEALTH.
- YOUR SHOWER MAY BE A SLIP AND FALL HAZARD CHECK WITH YOUR CONTRACTOR OR TILE MANUFACTURER REGARDING THE SAFE USE OF YOUR FLOORING IN A STEAM APPLICATION. SLIPPING AND FALLING INTO THE STEAM HEAD ITSELF OR INTO THE STREAM OF STEAM EMITTING FROM THE STEAM HEAD WILL CAUSE SERIOUS BURNS, OR PHYSICAL INJURY.
- DO NOT USE A STEAM ROOM WHILE UNDER THE INFLUENCE OF ALCOHOL OR DRUGS, AS THIS CAN BE HAZARDOUS TO YOUR HEALTH.
- IF YOU ARE FEELING UNCOMFORTABLE, DIZZY, FAINT, OR STARTING TO FALL ASLEEP, IMMEDIATELY EXIT THE STEAM ROOM.
- DO NOT USE A STEAM ROOM IF YOU ARE UNDER THE AGE OF 16 UNLESS SUPERVISED BY AN ADULT.
- THERMASOL GENERATORS ARE FOR INDOOR USE ONLY. THEY SHOULD NEVER BE LOCATED OUTSIDE THE HOME.
- THERMASOL GENERATORS ARE NOT TO BE USED FOR SPACE HEATING PURPOSES.
- FOR SAFETY, SMOOTH OPERATION PRACTICE AND LIABILITY. IF YOU ARE A PLUMBER/INSTALLER, PLEASE ENSURE THIS OWNERS MANUAL & WARRANTY INFORMATION IS IN THE OWNER'S POSSESSION WITH SPECIFIC DELEGATION FOR THE PURPOSE OF COMPLETELY FAMILIARIZING ANY USERS WITH THIS PRODUCT.
- FAILURE TO FOLLOW INSTALLATION INSTRUCTIONS SPECIFICALLY WILL CAUSE THE WARRANTY TO BE VOID.

Note: For better technical assistance and before contacting Technical Support, please have this model number, serial number, and date code ready.

PLACE SERIAL # HERE

DATE
CODE
HERE

TECHNICAL AND WARRANTY SUPPORT ONLY: 1-800-776-0711
(Monday – Thursday, 7:00 a.m. to 5:00 p.m. PST; Friday, 8:00 a.m. – 12:00 p.m. PST)

FOR ALL OTHER CUSTOMER SUPPORT PLEASE CONTACT YOUR DEALER

Sizing Your Steam Room

Steam Room Size Formula: $L \times W \times H = \text{volume in cubic feet (ft}^3\text{)}$

All measurements to be in units of feet. For non-standard ceilings (above 8 ft. high), apply a correction factor (add 10% per foot).

Examples: a 9 ft. ceiling requires correction factor 1.1 x (room size)
a 10 ft ceiling requires correction factor 1.2 x (room size)

Model Number	Steam Room Capacity (cu. ft.)
PP-450-240	450
PP-600-240	600
PP-800-240	800
PP-450-480	450
PP-600-480	600
PP-800-480	800

For further assistance call toll-free 800-776-0711

Generator Installation Instructions

Parts Enclosed

- Steam generator / built-in control
- Steam room sensor & 25 foot lead wire
- Polished chrome steam head
- 60 Minute Mechanical Timer

Materials Needed

- Brass ball valve
- Pipe compound
- Copper or brass nipples (Size and quantities per Instructions)
- In-line filter (recommended)
- 3/8" brass or copper union
- Wire (sizes and quantities per Instructions)
- Copper tubing or pipe
- Wire cap nuts
- Flex conduit
- Brass or copper tee fitting & plug

Tools Needed

- Pipe wrench
- Tubing cutter
- Flaring tool (if flared fittings are used)
- Pipe thread cap
- Wire cutters or wire strippers
- Adjustable wrench
- Screwdrivers (Philips & slotted)
- Solder & flux
- 3/16" & 1.5" masonry drill bits
- Drill motor
- Propane torch
- Other tools as required



Figure 1: Generator Dimensions

All ThermaSol steam generators are designed to build NO PRESSURE during operation. This is for your safety.

NOTE: Failure to follow instructions specifically will cause warranty to be void.

Installation Requirements

1. Use copper or brass fittings only. **NEVER USE GALVANIZED FITTINGS!**
2. The water inlet, steam outlet, and pressure relief valve, require brass unions.
3. The **generator must be upright, accessible and on a level surface** with **all** connections on the back. **The Access Panel (top and front of unit), as well as rear of the unit must be unobstructed and allow for easy access.**
4. Unit may be installed up to 50 feet away from shower area.
5. **Do not** plumb a trap in the steam line or plumb the pressure relief valve into the steam line.
6. Pitch steam line back towards generator avoid **perfectly level plumbed lines.**
7. Before connecting water line to the generator, flush water line into a five-gallon pail to remove any silt or other materials that may be in the line. A ThermaSol in-line water filter is recommended.

Caution: If the unit is run without water, serious damage may result! This possible damage is not covered under ThermaSol's limited warranty.

Note: Failure to follow specific installation instructions will cause the warranty to be void.

Water Inlet

Refer to Figure 2A for the following:

1. Connect tee to the hot or cold water line. Install copper pipe or tubing to the tee. If an in-line filter is to be installed on the water line to the generator, (which is suggested), it would be preferable to install the tee on the cold water line.
2. Install a brass shut-off valve on the water inlet line in an accessible area prior to the brass union and recommended in-line water filter.
3. Before making the last connection to the 3/8" water inlet line coming to the unit, flush the water line into a five-gallon pail to remove any silt or other materials that may be in the line.
4. Make the final connection and turn on water. All ThermaSol generators are equipped with an automatic water fill system. The water will stop after unit is filled.

IMPORTANT: MAXIMUM WATER PRESSURE IS 70 P.S.I.

STEAM HEAD INSTALLATION

Parts Enclosed

- Deluxe steam head
- Escutcheon

Tools Needed

- Pipe wrench
- 1.5" cutting tool
- Silicone gun
- Other tools as required



IMPORTANT NOTE!

LOCATE THE STEAM HEAD 6" INCHES BELOW CEILING AND 6 INCHES FROM NON BENCHED/SEATED/DOOR INTERIOR WALL CORNER. STEAM HEAD IS TO BE MOUNTED AS FAR AS POSSIBLE FROM TYPICAL BATHING POSITION (SEATED OR STANDING) AND AS FAR FROM CONTROL AS POSSIBLE WHILE MAINTAINING APPROXIMATELY A – 60" CONTROL HEIGHT.

1. Drill a 1 1/2" diameter hole in the shower wall or wall above the bathtub for the steam outlet line.
2. Connect 1" copper pipe or copper tubing onto the steam outlet with a 1" union. Run a 1" copper pipe from the union to the 1 1/2" hole in wall.
3. Attach the steam head and escutcheon to the copper pipe. **CAUTION: Do not obstruct the steam line with any shut-off valves, plugs or caps. All Steam Suite generators are designed to build NO PRESSURE.**
4. The steam line can run up, down, or horizontal; but **cannot run down and then up**. If it does, a steam trap will be produced at the low point blocking the flow of steam. Insulate the steam outlet piping if the piping run exceeds 10 feet or is exposed to cold areas. **NOTE: Use steam rated insulation (225 °F minimum).**

WARNING: Avoid contact with steam head! It will burn you. Avoid direct contact with the steam coming out of the steam head! It is extremely hot! It will burn you!

NOTE: DO NOT mount sensor near steamhead!

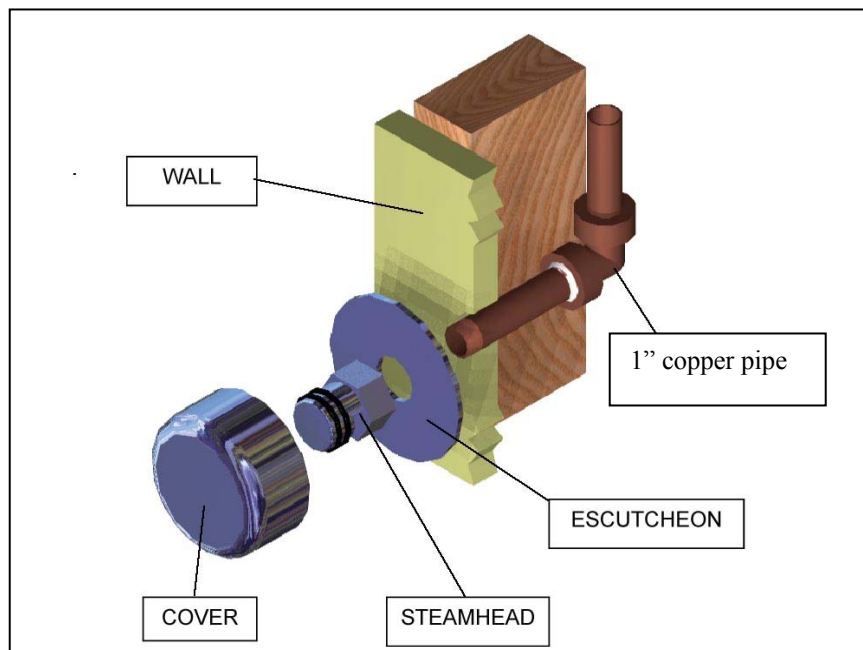

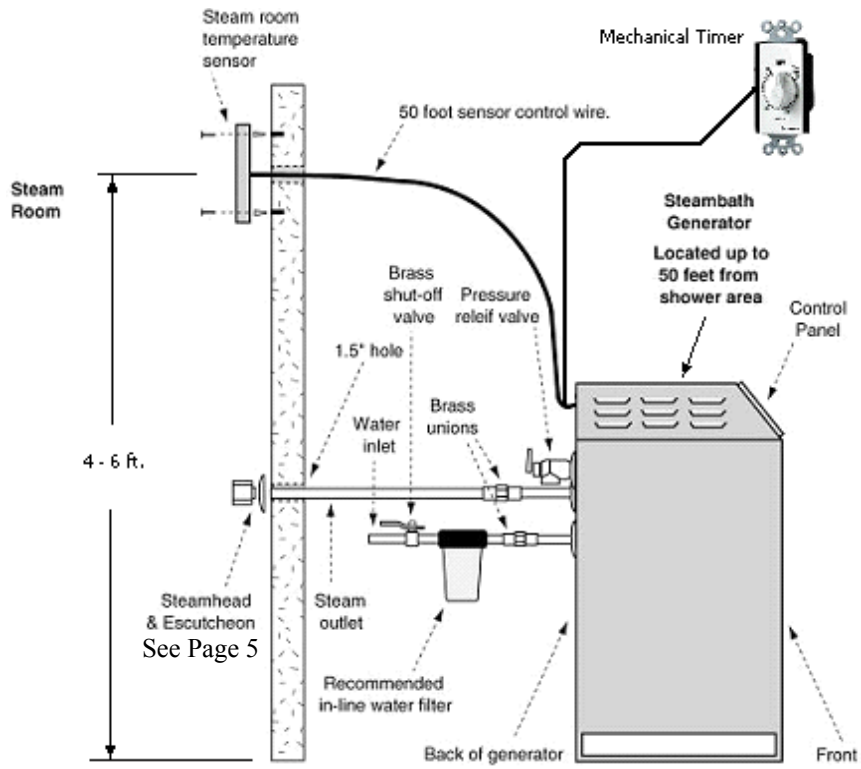

CONSUMER WARNING

WARNING

DO NOT USE THIS PRODUCT UNLESS YOU HAVE CONSULTED WITH YOUR DOCTOR AND RECEIVED WRITTEN PERMISSION TO DO SO. USE OF THIS PRODUCT MAY BE HAZARDOUS TO YOUR HEALTH.

WARNING

NEVER ATTEMPT TO FILL AROMA RESERVOIR ON THE STEAM HEAD WHEN UNIT IS IN THE ON POSITION. SEVERE BURNS MAY OCCUR.

WARNING

DO NOT USE AROMA THERAPY OILS OR SKIN CARE PRODUCTS OR ANY PRODUCT IN CONJUNCTION WITH YOUR UNIT WITHOUT CONSULTING WITH YOUR ALLERGIST OR DOCTOR BEFORE USE. THESE PRODUCTS MAY BE HAZARDOUS TO YOUR HEALTH.

WARNING

YOUR SHOWER MAY BE A SLIP AND FALL HAZARD CHECK WITH YOUR CONTRACTOR OR FLOORING MANUFACTURER REGARDING THE SAFE USE OF YOUR FLOORING IN A STEAM APPLICATION. SLIPPING AND FALLING INTO THE STEAM HEAD ITSELF OR INTO THE STREAM OF STEAM EMITTING FROM THE STEAM HEAD WILL CAUSE SERIOUS BURNS, OR PHYSICAL INJURY.

WARNING

STEAM IS HOT! DO NOT TOUCH OR GO NEAR THE STEAM HEAD FROM THE TIME THE UNIT IS "ON", UP TO ONE HOUR AFTER IT HAS SHUT OFF. SEVERE BURN WILL OCCUR IF YOU COME IN CONTACT WITH THE STEAM HEAD OR STEAM EMITTING FROM THE STEAM HEAD.

WARNING

DO NOT USE STEAM ROOM WHILE UNDER THE INFLUENCE OF ALCOHOL OR DRUGS, AS THIS CAN BE HAZARDOUS TO YOUR HEALTH.

WARNING

IF YOUR ARE FEELING UNCOMFORTABLE, DIZZY, FAINT, OR STARTING TO FALL ASLEEP IMMEDIATELY EXIT THE STEAM ROOM.

WARNING

DO NOT USE STEAM ROOM IF YOU ARE UNDER THE AGE OF 16 UNLESS SUPERVISED BY AN ADULT.

Electrical Installation

Note: All electrical wiring must be done per local electrical codes

Wire sizes recommended by National Electric Code. Minimum wire temperature rating 90 °C.

Generator Model	Voltage	Phase	Wire Gauge	Load Amps	Breaker Size	Fuse	Cubic Feet	kW
PP-450-240	240V	3	8	35A	40A	30A	450	13.5
PP-600-240			6	47A	60A	40A	600	18
PP-800-240			4	63A	70A	45A	800	24
PP-450-480	480V		10	16A	25A	15A	450	13.5
PP-600-480			8	22A	30A	20A	600	18
PP-800-480			8	29A	40A	25A	800	24

1. Turn off all electricity to the working area at the main breaker panel.
2. Connect 240 or 480 VAC (model dependant) electrical lines to terminals labeled L1, L2, and L3 on the contactor (**Figure 3**). The system uses 4 wire (3 phase and ground). See wiring diagrams (**Figure 4**).
3. Install the temperature control sensor with bulb guard in the steam room 4 to 6 feet above the floor (**Figure 2A**).

NOTE: DO NOT mount sensor near steam head!

4. Bring the control sensor wire to the generator. With the top cover removed (**Figure 3**) connect the control sensor wires, using ¼” push-on connectors to the control panel labeled “TEMP SENSOR”.
5. Connect Control Timer to the “TIMER” connection on the control panel using two ¼” push-on connectors.
6. Replace top access cover. **Turn on both water and power to the generator!** Instructions continue in page 10.
7. Test the touch pad to ensure it is properly wired. If any technical problems arise, call toll-free 800-776-0711.

Failure to follow installation instructions specifically may cause the warranty to be void!

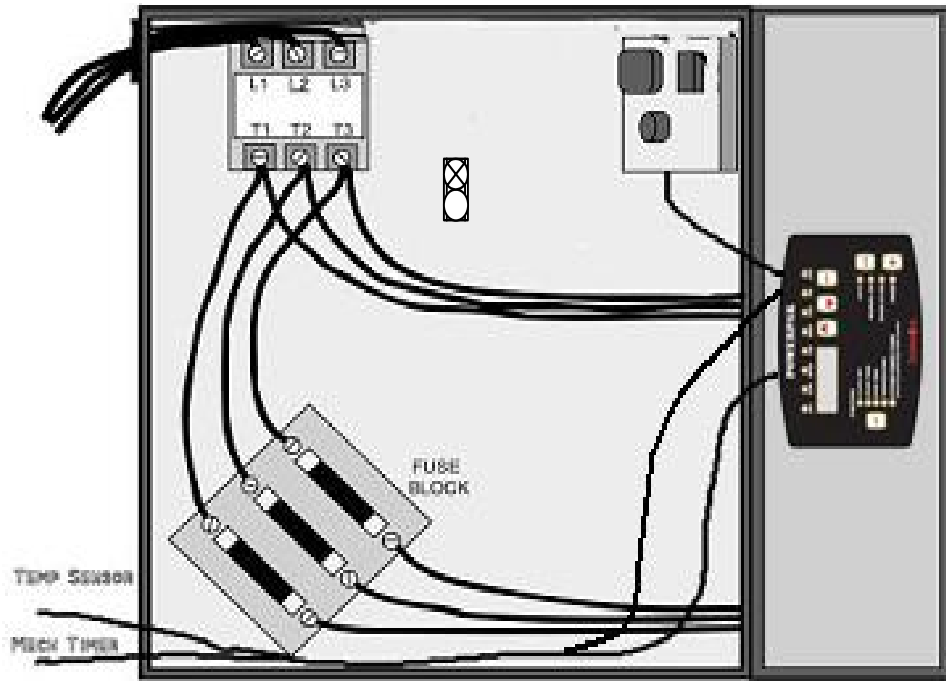

Figure 3A: 240V Wiring Diagram

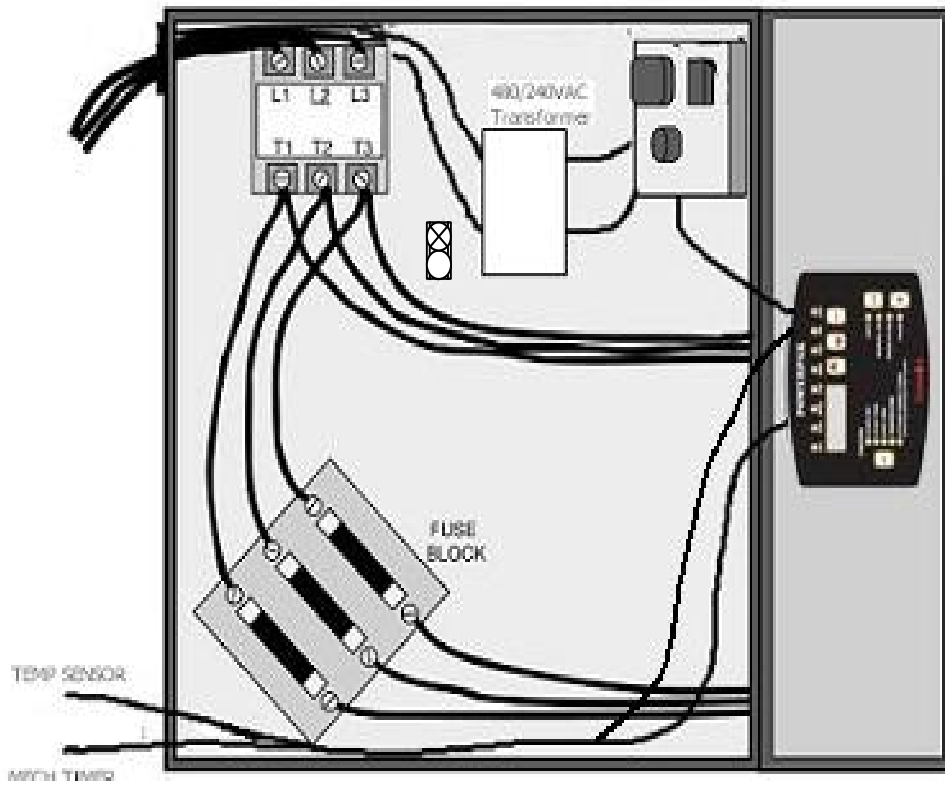

Figure 3B: 480V Wiring Diagram

CONSUMER WARNING

WARNING

DO NOT USE THIS PRODUCT UNLESS YOU HAVE CONSULTED WITH YOUR DOCTOR AND RECEIVED WRITTEN PERMISSION TO DO SO. USE OF THIS PRODUCT MAY BE HAZARDOUS TO YOUR HEALTH.

WARNING

NEVER ATTEMPT TO FILL AROMA RESERVOIR ON THE STEAM HEAD WHEN UNIT IS IN THE ON POSITION. SEVERE BURNS MAY OCCUR.

WARNING

DO NOT USE AROMA THERAPY OILS OR SKIN CARE PRODUCTS OR ANY PRODUCT IN CONJUNCTION WITH YOUR UNIT WITHOUT CONSULTING WITH YOUR ALLERGIST OR DOCTOR BEFORE USE. THESE PRODUCTS MAY BE HAZARDOUS TO YOUR HEALTH.

WARNING

YOUR SHOWER MAY BE A SLIP AND FALL HAZARD CHECK WITH YOUR CONTRACTOR OR FLOORING MANUFACTURER REGARDING THE SAFE USE OF YOUR FLOORING IN A STEAM APPLICATION. SLIPPING AND FALLING INTO THE STEAM HEAD ITSELF OR INTO THE STREAM OF STEAM EMITTING FROM THE STEAM HEAD WILL CAUSE SERIOUS BURNS, OR PHYSICAL INJURY.

WARNING

STEAM IS HOT! DO NOT TOUCH OR GO NEAR THE STEAM HEAD FROM THE TIME THE UNIT IS "ON", UP TO ONE HOUR AFTER IT HAS SHUT OFF. SEVERE BURN WILL OCCUR IF YOU COME IN CONTACT WITH THE STEAM HEAD OR STEAM EMITTING FROM THE STEAM HEAD.

WARNING

DO NOT USE STEAM ROOM WHILE UNDER THE INFLUENCE OF ALCOHOL OR DRUGS, AS THIS CAN BE HAZARDOUS TO YOUR HEALTH.

WARNING

IF YOUR ARE FEELING UNCOMFORTABLE, DIZZY, FAINT, OR STARTING TO FALL ASLEEP IMMEDIATELY EXIT THE STEAM ROOM.

WARNING

DO NOT USE STEAM ROOM IF YOU ARE UNDER THE AGE OF 16 UNLESS SUPERVISED BY AN ADULT.

ThermaSol PowerPak Series Control Operating Instructions

1. Ensure electrical/plumbing installation is complete (see page 7, note 6) – turn on power to unit at the breaker. You will see a message SET CLOC that means a valid time has to be set prior to any operation. To proceed, press DAY button once. The display will change to 00:00 and the day will blink Sunday. Wait 5 seconds. After 5 seconds, the system will accept this as the valid time. To set the correct time, use the UP or DOWN to adjust the time. Press DAY until you reach the correct day of week. Wait 5 seconds. After 5 second, the display will now show the time and day of the week. The time displayed is a 24-hour clock while the day of week of marked by an led next to the DAY label.

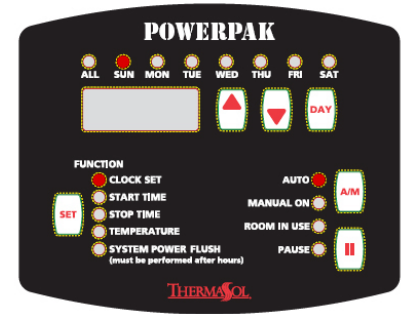

2. Now you will set the “Steam Start Time”. Press the SET button once. You should see the light next to the “Start Time” come on and red light next to ALL day. The ALL feature sets the start time for all 7 days. This saves time on entering redundant information 7 times. Using the DAY button, you can individually change the start time of a specific day. The system comes from the factory with default values of 7:00 start time for all seven days. Using the arrows set the time you want the steam to begin on that day from now onward.

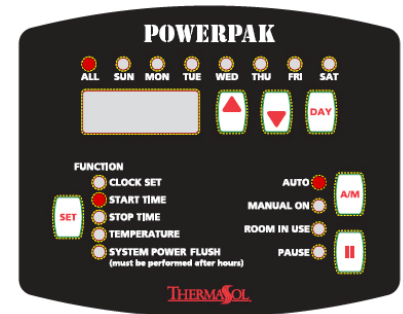

3. Next, set the “Steam Stop Time” using similar way as the Start Time. Press the SET button once. You should see the light next to the “Stop Time”. Using the arrows set the time you want the steam to stop for that day from now onward. Note that you are either programming a specific day or ALL (1 week). If ALL was the day configured, the settings will be applied to all 7 days. If there is a need to modify specific days, press DAY to move to the desired day to modify the time.

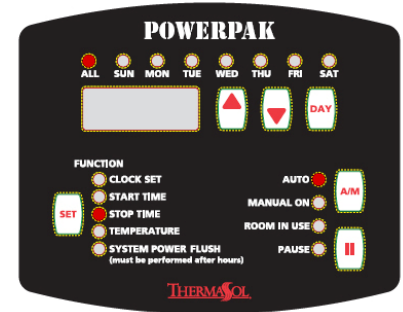

4. Pressing the SET button will let you see the current steam room temperature, and also enable you to configure the Temperature Set Point. Upon a first press of UP or DOWN, the set point will be displayed. Using the arrows set the temperature you want to be stored as the Set Point. This Generator will use this temperature as a threshold for turning on and off while keeping the steam room at constant desired temperature. This temperature is applied to all 7 days a week. After programming, to have the unit steam immediately, press the MANUAL button once.

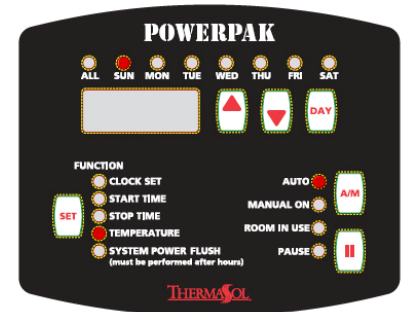

5. Pressing the SET button once again will enable you to set the Power Clean System (**Figure 4**) start time. You should see the light next to the “Power Clean Time” come on and the display will show the Power Clean time for the configuration day. Using the arrows, set the time you want the flush to start for that day from now press the DAY button for each day and using the arrows to set the time you want the unit to begin its Power Clean cycle. Once again the use of ALL for the day will apply the setting to all 7 days while pressing the DAY button will allow you to modify the time for any specific day. The Power Clean stops automatically at the end of its cycle. (Approximately 45 minutes). Power clean start time can occur before start time (00:00 midnight, with 07:00 start) or after hours (20:00 stop time, and 23:00 power clean start).

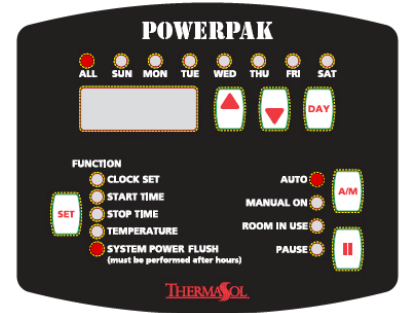

CAUTION:

Be sure there is no one in the shower area during this cycle!

Figure 4: Tank maintenance - power cleaning the tank.

**TECHNICAL AND WARRANTY SUPPORT ONLY: 1-800-776-0711
(Monday – Thursday, 7:00 a.m. to 5:00 p.m. PST; Friday, 8:00 a.m. – 12:00 p.m. PST)**

FOR ALL OTHER CUSTOMER SUPPORT PLEASE CONTACT YOUR DEALER

Controller Notes and Tips

- The system will revert back to displaying the current time and day after 1 minute of no button activity. The SET button is used to select between various display sets.
- The ALL day feature is extremely useful as it give an ability to quickly set start, stop, and power clean times for all days. Then on days such as weekend days, the user can modify only those days eliminating the need to enter redundant information.
- The system is equipped with usage odometer embedded in a special diagnostics menu. Pressing and holding the SET button for 5 seconds, will show the current firmware version of the control, this feature is important for customer service support. After 2 seconds, the display will show the total hours the generator was on (heater on) in 10-hour increments. This number would help service the unit more efficiently as it will provide usage/time information.
- The start, stop, and power clean times are related to each other automatically. The system is shipped from the factory with default values of 7:00 start, 20:00 stop, and 23:00 power clean for all 7 days. The user can always revert (reset) back to these original defaults by pressing and holding the UP and DOWN buttons simultaneously for 5 seconds.
- If the start time reaches the stop time, the system will automatically fix that by pushing the stop time forward. Similarly, if stop reached start, it will attempt to push start backwards if possible until reaching 00:00. If both times will reach 5 minutes of power clean, the system will try to jump over 50 minutes after power clean, if it is unsuccessful, it will remain in previous setting.
- The system supports temperature in both Fahrenheit and Celsius with a default factory setting of Fahrenheit. To change the units to Celsius, press the set button until you reach Temperature menu, and then press and hold the DAY button for 5 seconds and release. The system will toggle between units every 5 seconds while DAY button is depressed.
- The MANUAL button enables operation without timing constrains set by start, stop, and power clean cycle. Pressing MANUAL will be marked by Manual mode red LED, turn on the generator and cancel power clean cycle. Automatic On and Off event will not control the generator. To cancel this mode, press the MANUAL button once again; the red LED will light next to Auto.
The PAUSE button will halt the generator from producing steam. Pause mode will be marked by a red LED next to PAUSE. To resume regular operation, Press once again on PAUSE.
- The system is equipped with a self-diagnostics error messaging system. Upon a system malfunction, an error message will be displayed with the following code numbers:

Err 0 - General Code Error	Err 6 - Max heat exceeded
Err 1 - Pause button stuck	Err 7 - Day button stuck
Err 2 - Up button stuck	Err 8 - Manual button stuck
Err 3 - Down button stuck	Err 9 - Temperature sensor is disconnected or not functioning
Err 4 - Set button stuck	
Err 5 - Float switch tripped for 10 seconds	

**** AFTER PROGRAMMING****

To have the unit steam immediately, press the **MANUAL** button once.

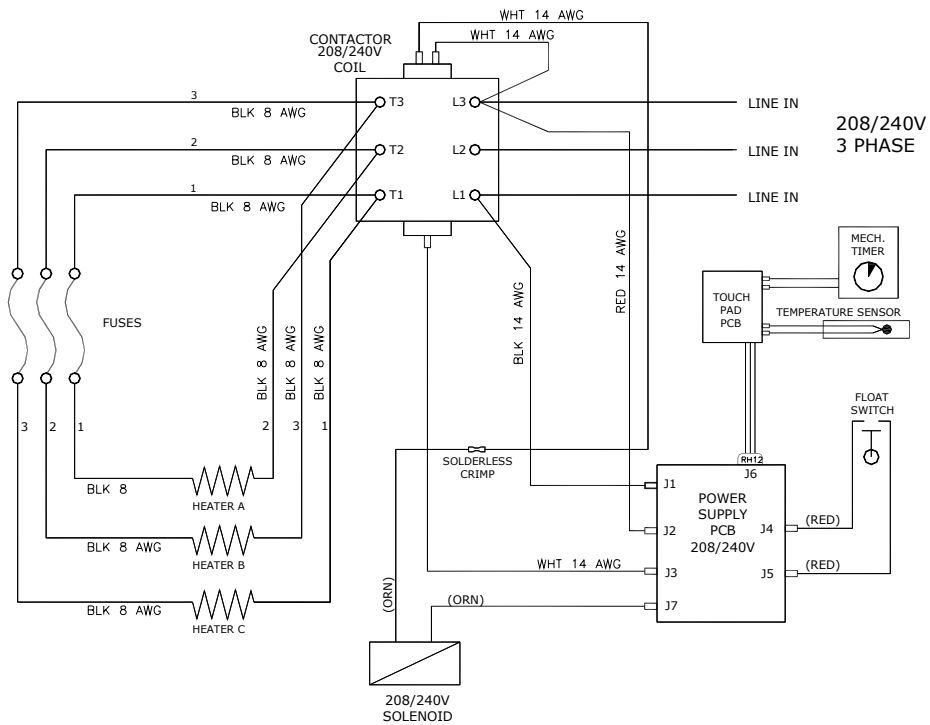

Figure 4A: System Wiring Diagram – 240VAC, 3-Phase

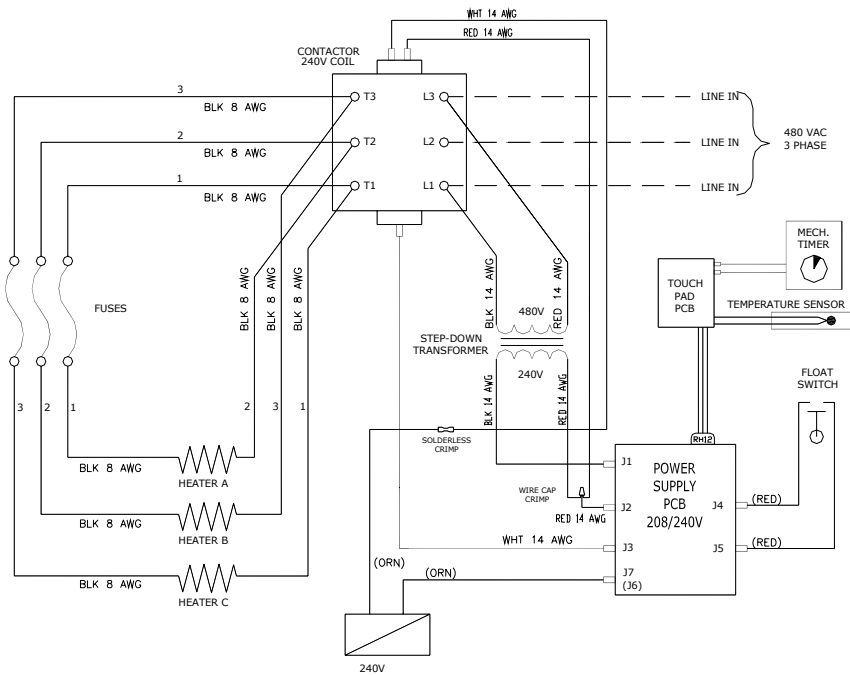

Figure 4B: System Wiring Diagram – 480VAC, 3-Phase

THIS PAGE INTENTIONALLY LEFT BLANK

POWERPAK WARRANTY

12-month warranty from date of purchase for PowerPak generators on all parts found to have a manufacturing defect and labor required to replace those parts.

EXCLUSION

- I. This service warranty does not cover: parts or product damaged in shipment; manufacturing defects observable prior to installation; parts or product damaged during installation; malfunction of equipment due to improper installation or installation not according to manufacturer specifications and/or installation instructions; use of cleaning solution not supplied by, or specifically approved by THERMASOL (Please refer to THERMASOL operating instruction manual for further information); parts or product installed in a manner that does not permit proper access to service; calcification build-up due to water condition and/or improper maintenance; damages to plated parts and accessories due to chemical corrosion or reaction; cosmetic damage; normal periodic cleaning and care or damage caused by not following manufacturer's cleaning instructions; repairs caused by accident; neglect, misuse, vandalism, fire, lightning, earthquake, or any other peril; unauthorized and/or improper modification or damage to structure. The Customer at the current labor and material charges shall pay any repair or installation modification that is subject to the above exclusion in effect at the time.
- II. THERMASOL will exercise reasonable efforts in rendering service under this warranty, but shall not be liable for any damage arising out of delays. This warranty only covers the repair and/or replacement as specified by the warranty.
- III. This warranty gives you specific legal rights and you may also have other rights, which may vary from state to state. Determination of rights under this warranty is in accordance with the laws in the state of California. Any dispute under the warranty must be submitted and resolved by arbitration in California.
- IV. THERMASOL does not guarantee that a local service person will be available. Unit may have to be removed and reinstalled at owner's expense. It is the responsibility of the buyer to file a claim with the carrier/carriers for any product that has shipping damage to or from THERMASOL. An RMA (Return Merchandise Authorization) must be obtained from the factory and used on any correspondence or packages sent to the factory. **THERMASOL, 2255 Union Place, Simi Valley, CA 93065 800-776-0711**

TERMINATION

This warranty will be terminated by THERMASOL for the following reasons: Improper installation or use; service to equipment by unauthorized personnel; installation that does not permit proper access for service; non-payment of repairs not covered under warranty; **non-remittance of completed warranty card**. Modification to unit not authorized by THERMASOL; use of non-THERMASOL repair parts.

THERMASOL POWERPAK REGISTRATION CARD / COMMERCIAL UNIT

NAME OF FACILITY: _____ PHONE: () _____
ADDRESS: _____ CITY: _____ STATE: _____ ZIP: _____

EMAIL: _____

I first heard about THERMASOL (please check one:)

- in a magazine/newspaper ad at a consumer trade show at the dealer or outlet where I purchased generator
 Website Other _____

SERIAL NO.: _____ MODEL: _____
DATE OF PURCHASE: _____ DEALER/OUTLET: _____

INSTALLER NAME: _____ PHONE: () _____
INSTALLER ADDRESS: _____ CITY: _____ STATE: _____ ZIP: _____

CUSTOMER SIGNATURE: _____ DATE INSTALLED: _____

The generator is working: Satisfactory Unsatisfactory Comments: _____

DOC 87006

REV A 02/05